



MULTI PORT THREE PIECE 3-WAY BALL VALVES

Bottom Flow / Tri-Pro Series
Diverter Design

Models:

Full Bore: 3W-HPF
Reduced Bore: 3W-HPS

Sizes:

1/2" - 2"

Pressure Rating:

1500 MAWP/WOG

Materials & Ends:

Stainless or Carbon Steel

NPT, SW or BW

Class 600 Flanged Ends

Weld End Type Valves can be
welded without disassembly

Optional: SS Body with Carbon
Steel End Connections

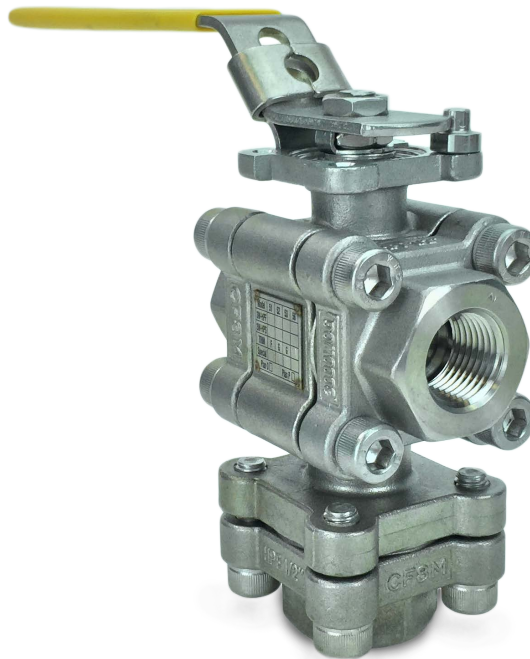

Plan O



Plan P

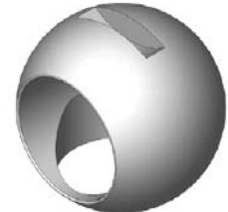

NON-TRANSFLOW DESIGN

Flow can't occur across the outlets during position change, therefore there will be very little mixing of products. The valve requires 180° rotation, with line flow shut off at the inlet (bottom port) at 90° rotation, and full diverter flow resumed to the other outlet port at 180° rotation.

FLO-TITE'S BOTTOM FLOW SERIES

Provides engineers greater design flexibility making the Flo-Tite valve a valuable choice for a multitude of applications.

Additional Valve Design Specifications can be found in Tech Bulletin 51 in the General Catalog.

FLOW PATTERNS

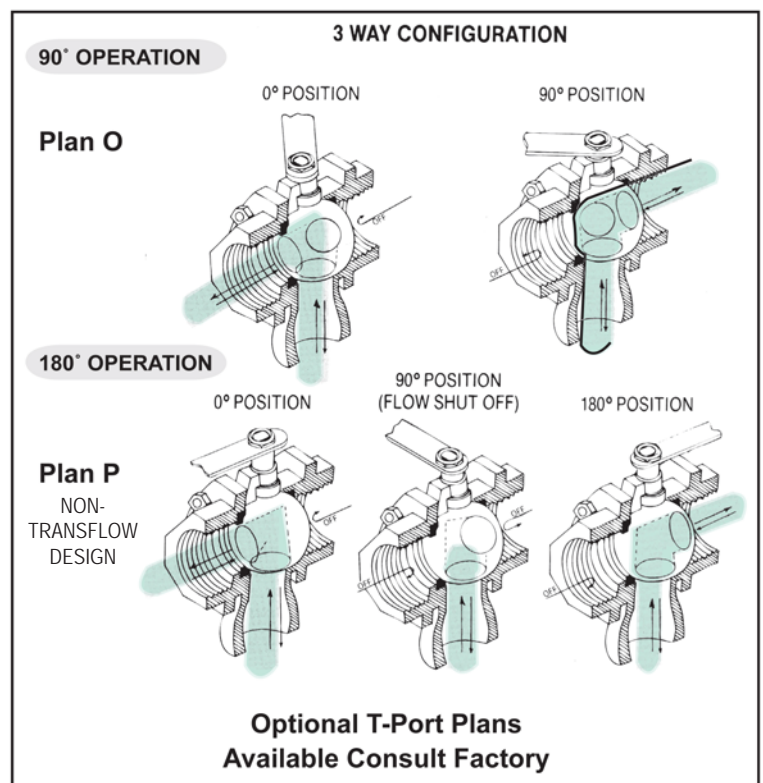

Bill of Materials

No.	Part Name	Material	Qty
1	Body	ASTM A351 CF8M	1
2	Caps	ASTM A351 CF8M	3
3	Ball	ASTM A351 CF8M	1
4	Seats #	TFM	2
5	Gaskets #	TFM	set
6	Bolts *	SS304	12
7	Stem	17-4PH	1
8	Thrust Bearing #	Carbon Filled PTFE	1
9	Thrust Washer #	50% PTFE + SS316	1
10	Stem Packings #	Graphite	set
11	Packing Follower	SS304	1
12	Belleville Washers	SS301	2
13	Lock Washer	SS304	1
14	Stem Nuts	SS304	2
15	Handle	SS304	1
16	Stopper	SS304	1
17	Handle Sleeve	Plastic	1
18	Locking Device	SS304	1
19	Anti-Static	SS316	1
20	O-Ring	VITON	1

Parts included in repair kits

Note: Stainless Steel Welding End
Material ASTM A351 CF3M

* 316SS Bolting Available

Pressure/Temperature Chart

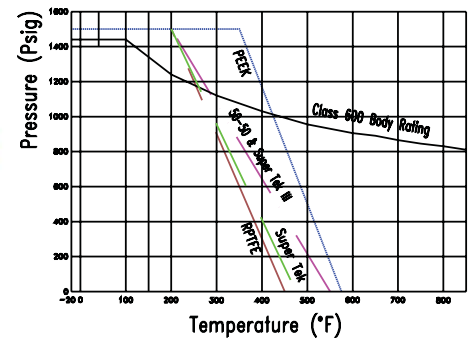

Design and Technical Data

Model Numbers:
Full Port: 3W-HPF
Reduced Port: 3W-HPS

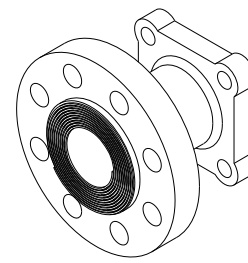
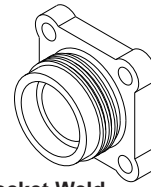
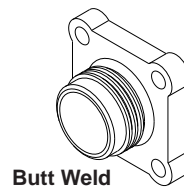
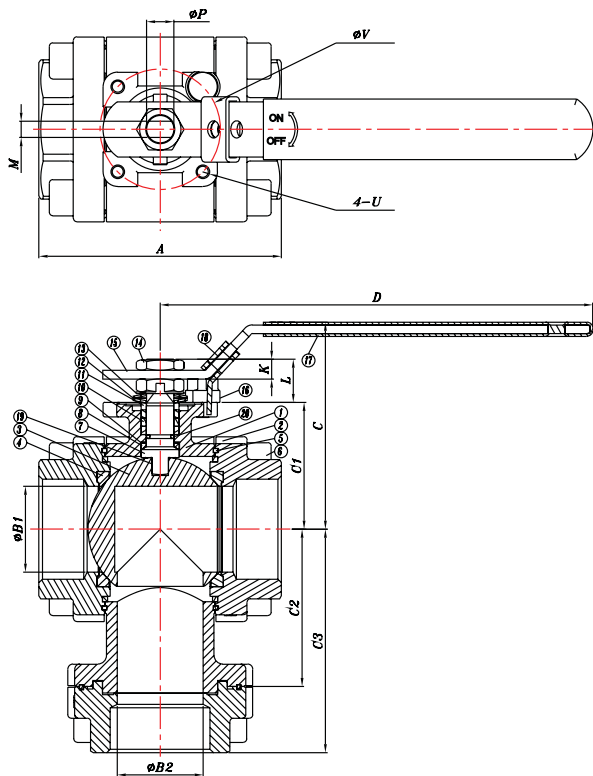

Optional: SS Body with Carbon Steel End Connections

All carbon steel valves are available on request.

Additional Technical Information can be found in Tech Bulletin 51 in the General Catalog.

ATTENTION
MAWP/WOG is a do not exceed pressure at normal ambient NPT & Weld End Models

Dimensions and Weights: Full Port 3W-HPF

SIZE	A			B1	B2	C	C1	C2	C3			K	L	M	P	U	V	Cv	ISO Pad	Torque In-Lb	Weight Lb
	NPT	SW/BW	CL 600 Flange						NPT	SW/BW	CL 600 Flange										
1/2"	2.91	4.89	6.50	0.59	0.39	2.69	1.54	1.83	2.80	3.78	4.59	0.28	0.53	0.25	0.47	#10-24unc	1.42	7	F04	90	2.7
3/4"	3.46	5.24	7.58	0.79	0.79	2.85	1.70	2.24	3.35	4.24	5.40	0.28	0.53	0.25	0.47	#10-24unc	1.42	15	F04	147	4.2
1"	3.70	5.24	8.50	0.79	0.79	3.44	2.06	2.54	3.78	4.55	6.18	0.44	0.74	0.315	0.55	1/4-20unc	1.65	15	F05	200	6.0
1 1/2"	4.61	6.19	9.50	1.26	1.26	4.24	2.65	3.01	4.41	5.20	6.86	0.53	0.88	0.374	0.63	5/16-18unc	1.97	40	F07	452	12.0
2"	5.55	6.98	11.85	1.97	1.97	4.49	2.90	3.60	5.12	5.83	8.27	0.53	0.88	0.374	0.63	5/16-18unc	1.97	108	F07	588	20.0

Dimensions and Weights: Reduced Port 3W-HPS

SIZE	A			B1	B2	C	C1	C2	C3			K	L	M	P	U	V	Cv	ISO Pad	Torque In-Lb	Weight Lb
	NPT	SW/BW	CL 600 Flange						NPT	SW/BW	CL 600 Flange										
3/4"	3.11	4.89	c/f	0.59	0.39	2.69	1.54	1.83	2.89	3.78	c/f	0.28	0.53	0.25	0.47	#10-24unc	1.42	5	F04	90	2.7
1"	3.70	5.24	c/f	0.79	0.79	2.85	1.70	2.24	3.46	4.24	c/f	0.28	0.53	0.25	0.47	#10-24unc	1.42	12	F04	147	4.2
2"	4.76	6.19	c/f	1.58	1.26	4.24	2.65	3.01	4.41	5.20	c/f	0.53	0.88	0.374	0.63	5/16-18unc	1.97	36	F07	452	12.0



Flo-Tite, Inc.
4815 West 5th St.
Lumberton, NC 28358

P. O. Box 1293
Lumberton, NC 28359
Website: www.flotite.com

Tel: (910) 738-8904
Fax: (910) 738-9112
E-mail: flotite@flotite.com